

# Rotary Limit switch

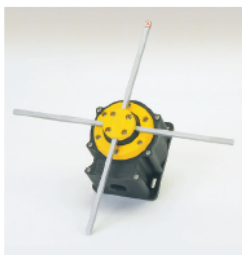

## Generelt

- FCR rotations endestop til eksempelvis reversering af motorer, slow down og stop for kraner.
- 6 varianter
- Husmateriale : Selvslukkede thermoplast der opfylder V0 UL 94
- Kabelindgang via Ø22,5mm hul

## Tekniske data

Opfylder IEC/EN60947-3, UL508  
 Certificater      
 Nom. Spænding 690V  
 Nom. Strøm 16A  
 Omgivelsestemperatur -25 - +55grc  
 Tæthedegrad IP65  
 Dobbeltisoleret

## 1 HASTIGHED

3 stillings med mekanisk interlock

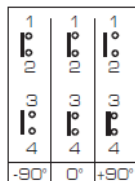
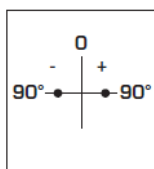

3 stillings med mekanisk interlock

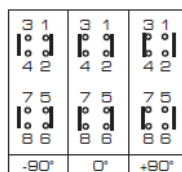
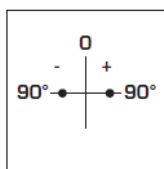

4 stillings roterende

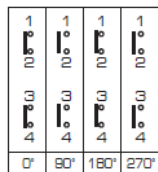
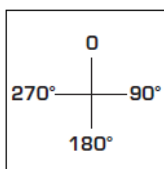

4 stillings roterende

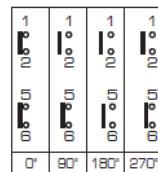
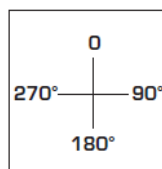

4 stillings roterende

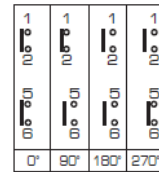
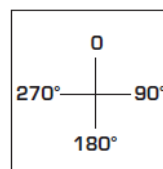

TYPE	VARENR./EANNR.	TYPE	VARENR./EANNR.	TYPE	VARENR./EANNR.	TYPE	VARENR./EANNR.	TYPE	VARENR./EANNR.
FCR001	8718234071285	FCR002	8718234071292	FCR003	8718234071308	FCR004	8718234071315	FCR005	8718234071322

## 2 HASTIGHEDER (SLOW DOWN)

## MÅLKITSE

4 stillings med mekanisk interlock

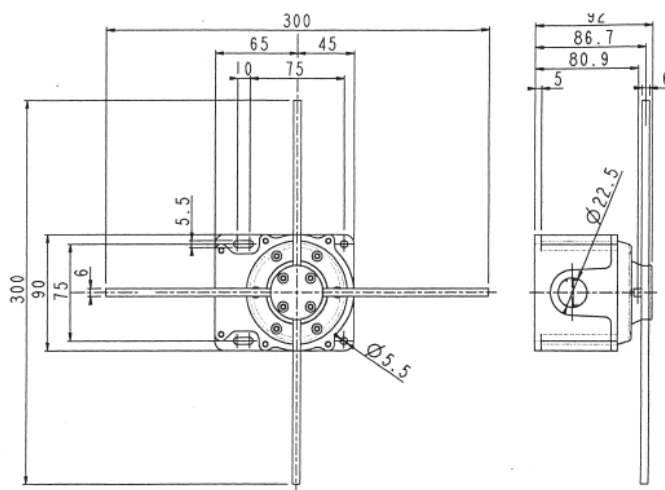
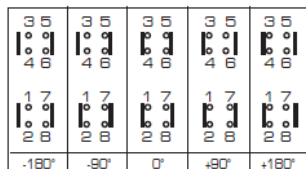
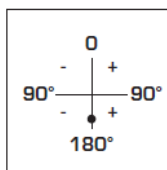

TYPE	VARENR./EANNR.
FCR006	8718234071339