

Anschlußschema

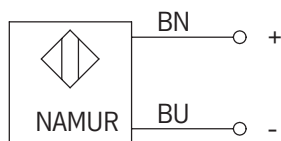

Stromkennlinie

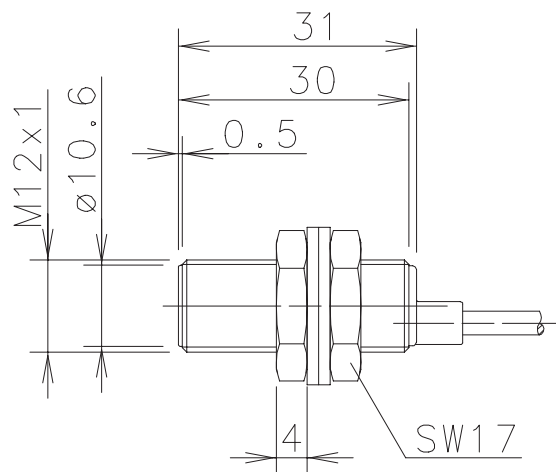
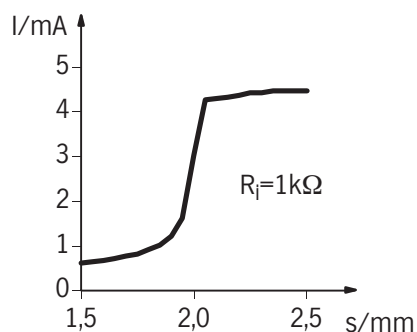

Kenndaten nach DIN EN 50227/06.1998

Elektrische Daten

Einbauart		bündig
Bemessungsschaltabstand	s_n	2mm (Schaltpunkt 1,5mA bei $U_n = 8V$ und $R_i = 1k\Omega$)
Wiederholgenauigkeit	R	< 5%
Normmeßplatte		12 x 12 x 1mm (Länge x Breite x Höhe), Fe
Nennspannung	U_n	DC 8 V
Bemessungsbetriebsspannung	U_e	DC 5 ... 25V
Restwelligkeit		≤ 5%
Stromaufnahme	I	> 3mA ($U_n = 8V$ und $R_i = 1k\Omega$) aktive Fläche frei < 1mA ($U_n = 8V$ und $R_i = 1k\Omega$) aktive Fläche bedeckt
Schaltfrequenz	f	≤ 800Hz
Eigeninduktivität	C_i	100μH
Eigenkapazität	L_i	55nF

Mechanische Daten

Umgebungstemperatur	-25°C bis +70°C
Schutzart	IP 67
Schwingbeanspruchung	10 - 55Hz, a = 1mm
Schockbeanspruchung	30g, $t_{Stoß} = 11ms$
Frontkappe	PA 6.6, blau
Gehäuse	Messing, vernickelt
Abschlußkappe	PA 6, blau
Anschlußbart	Kabel 2 x 0,25mm ² x 2m; PVC-Mantel, blau
Befestigungshilfen	2 x Sechskantmutter und 2 x Zahnscheibe

Wiring Diagram

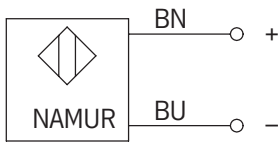

Current Characteristics

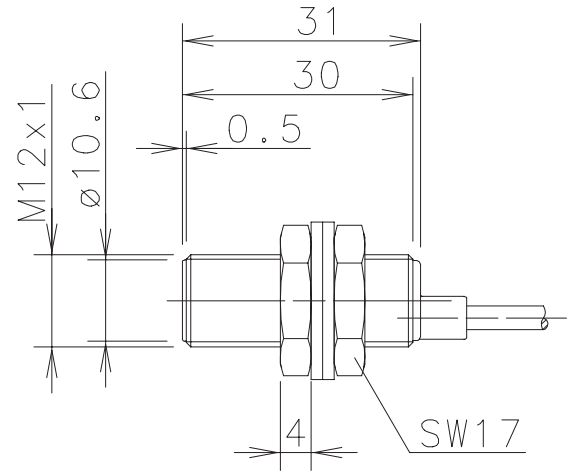
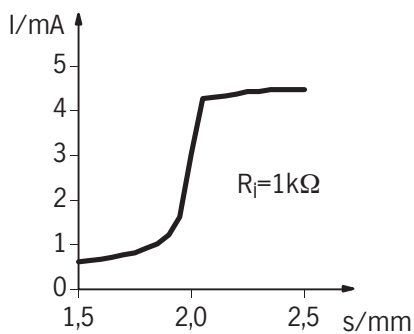

Technical Data according to DIN EN 50227/06.1998

Elektrical Data

Mounting		flush
rated operating distance	s_n	2mm (switching point 1,5mA @ $U_n = 8V$ and $R_i = 1k\Omega$)
Repeat accuracy	R	< 5%
Standard target		12 x 12 x 1mm (length x width x thickness), Fe
Rated voltage	U_n	DC 8 V
Rated operational voltage	U_e	DC 5 ... 25V
Ripple		≤ 5%
current input	I	> 3mA ($U_n = 8V$ und $R_i = 1k\Omega$) sensing face free < 1mA ($U_n = 8V$ und $R_i = 1k\Omega$) sensing face damping
Frequency of operating cycles	f	≤ 800Hz
Self-inductance	C_i	100μH
Self-capacitance	L_i	55nF

Mechanical Data

Operating temperature	-25°C bis +70°C
Type of protection	IP 67
vibratory stresses	10 - 55Hz, a = 1mm
shock resistance	30g, $t_{Sto\beta} = 11ms$
Front cap	PA 6.6, blue
Housing	brass, nickel plated
End cap	PA 6, blue
Termination type	cable 2 x 0,25mm ² x 2m; PVC - Outer jacket, blue
For attachment	2 x hexagon nut and 2 x toothed washer