

**Standard enclosure**  
Series CT (Polycarbonate)

**Designation CT-861 Polycarbonate** **Article number 286000000**

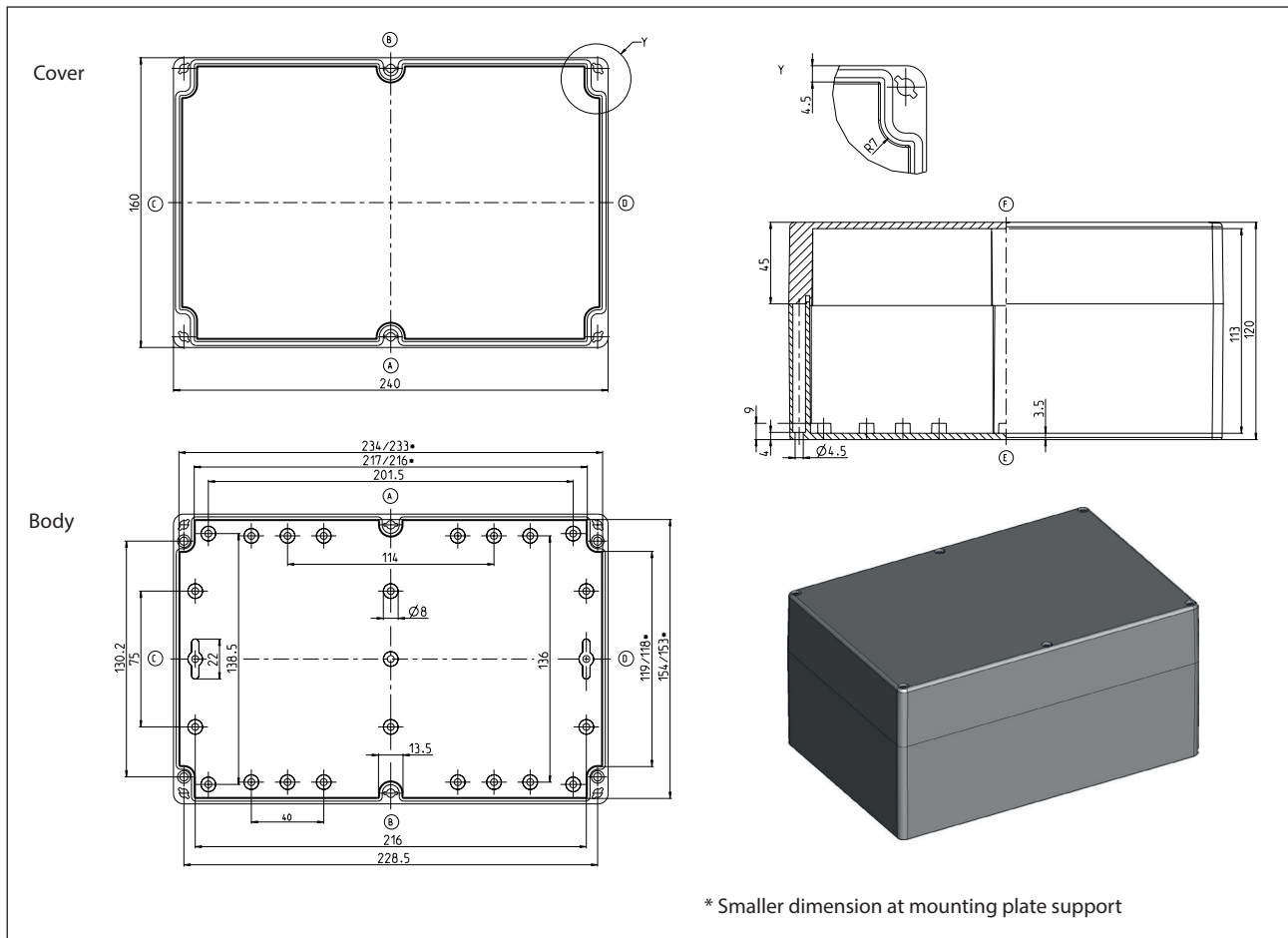

**Standard version**

Scope of supply:

- Base of enclosure
- Enclosure cover
- Quick-release screw (cross recessed head) enclosed loosely
- Colour RAL 7035 (light grey)
- Cover gasket PUR (polyurethane)
- Internal mounting plugs for selftapping screws (are included)
- Individually packaged in foil

**Maximum possible number of thread** (figures for identical diameter, not mixed!)

ISO M	M12	M16	M20	M25	M32	M40	M50	M63
Page A/B	36	16	12	8	4	2	2	2
Page C/D	17	8	5	3	2	2	1	0

**Property chart CT-861**

Specification	Value	According to the standard	Remark
<b>General data:</b>			
Weight	785 g		
External dimensions	240 x 160 x 120		
Protection classes			
IP code	IP 66	EN 60529	
IK code	IK 07	IEC 62262	
Material			
Enclosure	Polycarbonat (PC)		light grey
Quick-release fastener	1.4303		DIN EN 10088-3
Screws	A2 - 70		DIN EN ISO 3506-1
Seal	PUR (Polyurethan)		Colour: dark grey, 2-component polyurethane foam seal
Toxic behaviour	halogen-free		
<b>Thermal properties:</b>			
Fire behaviour			
Flammability	V-2	UL 94	Contentwise alike with EC60695-11-10 and IEC60695-11-20
glow wire test	960°C ; 2 mm	IEC 60695-2-12	
glow wire test	900°C ; 1mm	IEC 60695-2-12	
glow wire test			
Temperature range			
Enclosure without a seal	-40 °C bis +120 °C		
Seal PUR	-40 °C bis +100 °C		
Temperature index Enclosure material			
RTI (tensile strength)	80 °C	UL 746 B	
RTI (impact strength)	80 °C	UL 746 B	
RTI (dielectric strength)	80 °C	UL 746 B	
Ambient temperatur according to DIN EN 62208			
Indoor application	-5 °C bis +40 °C	DIN EN 62208	On the average over 24h +35°C
Relative humidity according to DIN EN 62208			
Indoor application	max. 50% bei -40 °C	DIN EN 62208	with low temperatures also higher (for ex. 90% at +20°C)
Storage temperature	-20 °C bis +60 °C		
Enclosure-specific thermal conductivity value	1,94 K/W		taking account of effective dissipation loss

**Property chart CT-861**

Specification	Value	According to the standard	Remark
<b>Mechanical properties:</b>			
Torques			
quick – release screw	1/4 Rotation		
Attachment of accessories	1,0 Nm		for ex. mounting plates, mounting rails
Other mounting	1,0 Nm		Screw channel, External mounting brackets
Maximum installation weight	2,6 kg		
<b>Electrical characteristics:</b>			
Protection class	II	EN 61140 / VDE 0140-1	 Protection by double or reinforced insulation
Rated voltage	max. 1000V		Maximum length of the extension arm
Surface resistivity	10 <sup>15</sup> Ohm	IEC 60093	
Dielectric strength	33 kv/mm	IEC 60243-1	
<b>More details:</b>			
General tolerance	mH	ISO 2768	
Product standard	Yes	DIN EN 62208	Empty enclosures for low-voltage switchgear assemblies
Approvals			
c UL us	Yes	UL508A / C22,2	Typ 1, 4, 4x indoor
Compliances			
RoHs	Yes	Directive 2011/65/EU	
CE label	Yes	EC-No 765/2008	
Low-Voltage-Directive No.:	2014/35/EU		

### Other versions / Accessories

The following information is not a standard. Approvals, compliances and protection classes of these versions upon request.

<b>Other version CT-861</b>	
Description of the modification compared with the standard version	Article number
PC, with screw fastener	2860001000

<b>Possible Accessories / as individual parts or as assembly set</b>	
Description of the modification compared with the standard version	Article number
Mounting plate	9512018000
Mounting rail TS 15	-
Mounting rail TS 32	9821006000
Mounting rail TS 35	9822008000
Earthing rail (secured on central bosses C/D)	9810009000
External mounting brackets	9802002000
External articulated hinges (mechanical machining of the enclosure required)	9802025000
Internal articulated hinges (flexible)	9801080000
Mounting bushes with 4 screws M3 x 8	9800040000

<b>Optional seals</b>			
Specification	Value	According to the standard	Remark
<b>Thermal properties:</b>			
CR seal	-30 °C bis +80 °C		IP65
Silicone foam seal	-60 °C bis +130 °C		on request
Silicone complete seal	-60 °C bis +200 °C		on request
EPDM seal	-35 °C bis +100 °C		on request
HF seal	-55 °C bis +125 °C		on request