

Standard enclosure
Series CA

Designation CA-350	Article number 135000000
---------------------------	---------------------------------

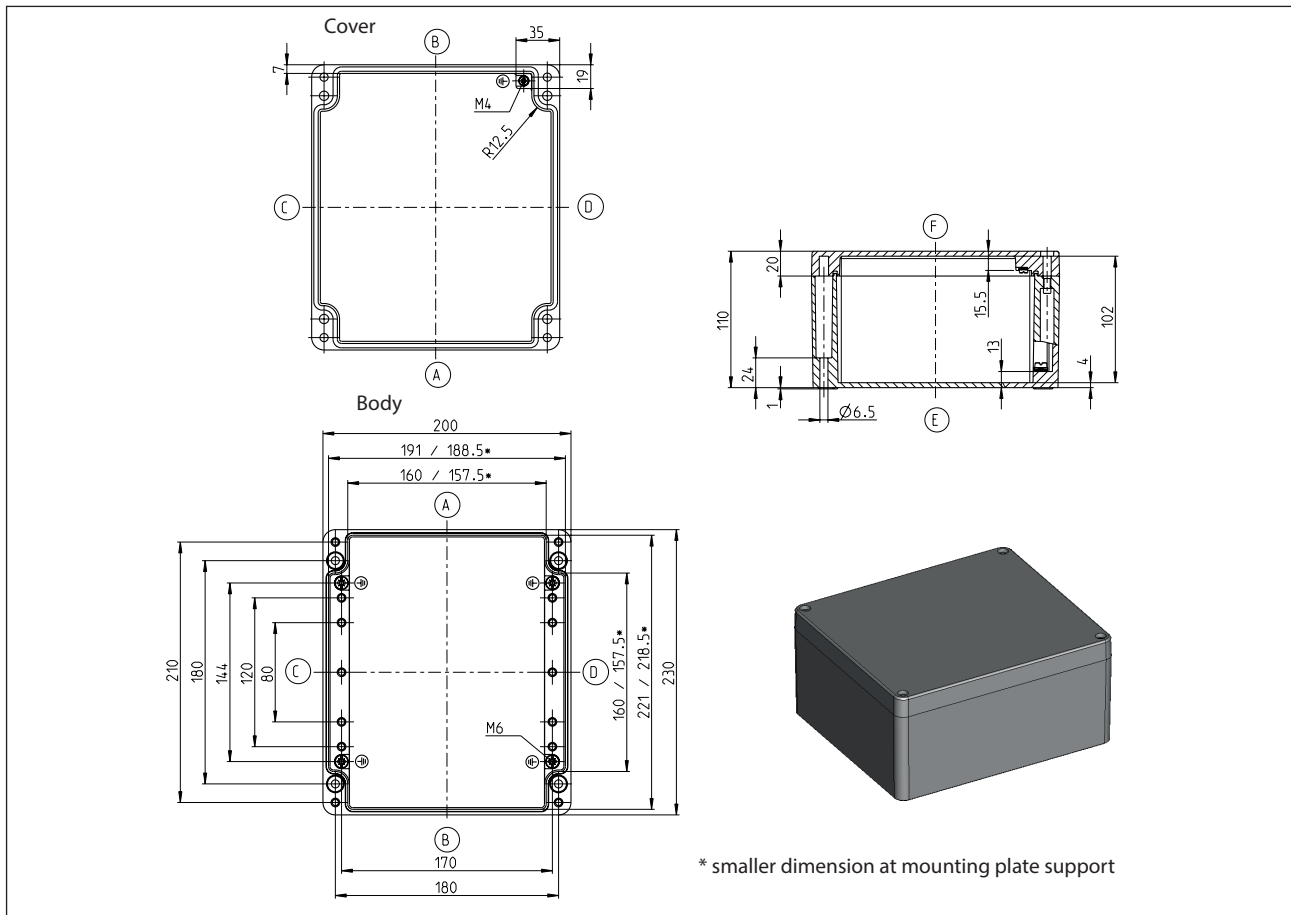

Standard version	
Scope of supply:	
Base of enclosure	
Enclosure cover	
Cover screws (cross recessed head) enclosed loosely	
Earthing screws in the lower part and in the cover	
Colour RAL 7001 (silver grey)	
Cover gasket PUR (polyurethane)	
Individually packaged in foil	

Maximum possible number of thread (figures for identical diameter, not mixed!)									
ISO M	M12	M16	M20	M25	M32	M40	M50	M63	
Page A/B	35	15	12	8	4	3	2	2	
Page C/D	26	12	8	5	3	2	2	1	

Property chart CA-350			
Specification	Value	According to the standard	Remark
General data:			
Weight	2730 g		
External dimensions	200 x 230 x 110		
Protection classes			
IP-code	IP66	EN 60529	
IP-code	IP67	EN 60529	
IK-code	IK09	IEC 62262	
Material			
Enclosure	EN AC-ALSi12Cu1(Fe) EN AC-44300	DIN EN 1706:05/98	Alumimium presssure die-casting Alloy 230
Screws	A2-70	DIN EN ISO 3506-1	Cover screws
Gasket	PUR (Polyurethan)		Colour: dark grey, 2-component polyurethane foam seal
Toxic behaviour	halogen-free		
Mechanical properties:			
Torques			
Cover screws	2,5 Nm		
Earthing screws	2,5 Nm 2,0 Nm		Body Cover
Attachment of accessories	2,5 Nm		for ex. mounting plates, mounting rails
Other mounting	2,5 Nm		Screw channel, External mounting brackets
Maximum installation weight	3,7 kg		
Thermal properties:			
Temperature range			
Enclosure without a seal	-30 °C bis +80 °C		Standard powder-coated enclosure
PUR-seal	-40 °C bis +100 °C		
Ambient temperature Indoor application	-5°C bis +40°C	DIN EN 62208	On the average over 24h +35°C
Thermal conductivity value	1,35 K/W		taking account of effective dissipation loss
Relative humidity			
Indoor application	max. 50% bei +40°C	DIN EN 62208	with low temperatures also higher (for ex. 90% at +20°C)
Storage temperature	-20°C bis +60°C		
Chemical properties:			
Corrosion resistance	Severity level A	DIN EN 62208/9.13.2.1	IEC 60068-2-30 and IEC 60068-2-11
Corrosion resistance	Severity level B	DIN EN 62208/9.12.2.1	IEC 60068-2-30 and IEC 60068-2-11
Resistance lists for enclosure materials and seals see catalog			

Property chart CA-350			
Specification	Value	According to the standard	Remark
Electrical characteristics:			
Protection class	I	EN 61140 / VDE 0140-1	 Protection by protective conductor
Rated voltage	max. 1000 V (AC) max. 1500 V (DC)		
More details:			
General tolerance	GTA 13/5	DIN 1688	Cast part tolerances
General tolerance	mH	ISO 2768	Machining tolerances
Product standard	Yes	DIN EN 62208	Empty enclosures for low-voltage switchgear assemblies
Approvals			
c UL us	Yes	UL508A / C22.2	Typ 1, 4, 4x, 12, 13
Compliances			
RoHs	compliant	Directive 2011/65/EU	
CE label	compliant	EG-Nr. 765/2008	
Low-Voltage-Directive No.:	2014/35/EU		

Other versions / Accessories

The following information is not a standard. Approvals, compliances and protection classes of these versions upon request.

Other versions CA-350	
Description of the modification compared with the standard version	Article number
HF seal and cover screws	1350008000
Unwashed, not painted, loose accessories	1350017000
CR gasket	upon request
UV-resistant powder (outdoor installation)	upon request
Packed in cartons (screwed-in cover screws)	upon request

Accessories / as individual parts or as assembly set	
Description of the modification compared with the standard version	Article number
Mounting plate	9511015000
Mounting rail TS 15	-
Mounting rail TS 32	9821003000
Mounting rail TS 35	9822005000
Earthing rail	9810007000
External mounting brackets	9824023000
External articulated hinges	9801047000
Internal articulated hinges with cover guide (mechanical machining of the enclosure required)	9801030000

Alternative seals			
Specification	Value	According to the standard	Remark
Thermal properties:			
CR gasket	-30 °C bis +80 °C		IP66
Silicone foam seal	-60 °C bis +130 °C		IP66 / IP67
Silicone complete seal	-60 °C bis +200 °C		IP66 / IP67
EPDM seal	-35 °C bis +100 °C		IP66
HF seal	-55 °C bis +125 °C		upon request